

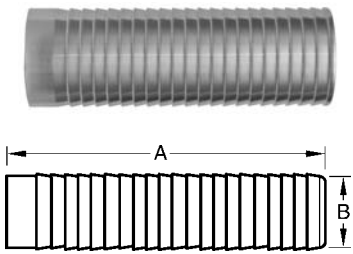

Butt Weld Adapters

Butt Weld Long Hose Adapters - 14WHRL



Tube OD	Dimensions		Nominal Wall	316L	
	A	B		Part Number	
1"	3.000	1.000	.116	14WHRL-R100	
1½"	4.500	1.500	.116	14WHRL-R150	
2"	4.500	2.000	.116	14WHRL-R200	
2½"	5.000	2.500	.116	14WHRL-R250	
3"	5.000	3.000	.116	14WHRL-R300	
4"	4.875	4.000	.116	14WHRL-R400	

Butt Weld Hose Adapters - 14WHR

H

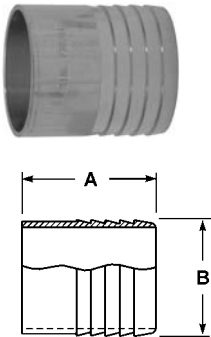

Tube OD	Dimensions		Nominal Wall	316L	
	A	B		Part Number	
½"	1.500	.500	.065	14WHR-R50	
¾"	1.500	.750	.065	14WHR-R75	
1"	1.688	1.000	.065	14WHR-R100	
1½"	1.688	1.500	.065	14WHR-R150	
2"	2.312	2.000	.065	14WHR-R200	
2½"	2.000	2.500	.065	14WHR-R250	
3"	3.093	3.000	.065	14WHR-R300	
4"	3.406	4.000	.083	14WHR-R400	

Butt Weld Elbows

90° Butt Weld Elbows with Tangents, #7 finish - B2S

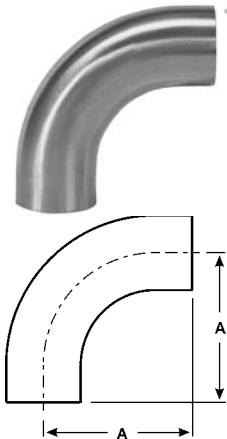

Tube OD	Dimension A	Nominal Wall	304	316L
			Part Number	Part Number
½"	3.000	.065	---	B2S-R50P
¾"	3.000	.065	---	B2S-R75P
1"	2.062	.065	B2S-G100P	B2S-R100P
1½"	2.937	.065	B2S-G150P	B2S-R150P
2"	4.062	.065	B2S-G200P	B2S-R200P
2½"	5.187	.065	B2S-G250P	B2S-R250P
3"	6.312	.065	B2S-G300P	B2S-R300P
4"	8.312	.083	B2S-G400P	B2S-R400P

Note: #3, #5 and electropolish finishes are available.

90° Butt Weld Elbows, #7 finish - B2WCL

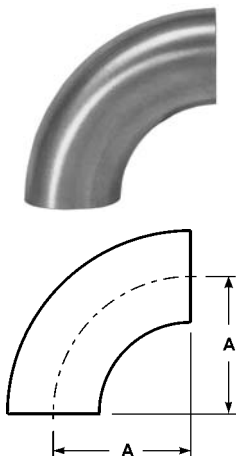



Tube OD	Dimension A	Nominal Wall	304	316L
			Part Number	Part Number
½"	1.125	.065	---	B2WCL-R50P
¾"	1.125	.065	---	B2WCL-R75P
1"	1.500	.065	B2WCL-G100P	B2WCL-R100P
1½"	2.250	.065	B2WCL-G150P	B2WCL-R150P
2"	3.000	.065	B2WCL-G200P	B2WCL-R200P
2½"	3.750	.065	B2WCL-G250P	B2WCL-R250P
3"	4.500	.065	B2WCL-G300P	B2WCL-R300P
4"	6.000	.083	B2WCL-G400P	B2WCL-R400P
6"	9.000	.109	B2WCL-G600P	B2WCL-R600P
8"	12.000	.120	B2WCL-G800P	B2WCL-R800P
10"	15.000	.109	B2WCL-G1000P	B2WCL-R1000P

Note: #3, #5 and electropolish finishes are available.

Buttweld Elbows

90° Threaded Bevel Seat x Buttweld Elbows, #7 finish - B2T

Tube OD	Dimensions		Nominal Wall	304	
	A	B		Part Number	
1"	2.780	2.062	.065	B2T-G100	
1½"	3.656	2.937	.065	B2T-G150	
2"	4.812	4.062	.065	B2T-G200	
2½"	6.062	5.187	.065	B2T-G250	
3"	7.218	6.312	.065	B2T-G300	
4"	9.343	8.312	.083	B2T-G400	

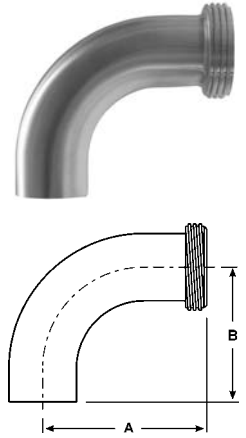

90° Clamp x Buttweld Elbows, #7 finish - B2CM

Tube OD	Dimensions		Nominal Wall	304	316L
	A	B		Part Number	Part Number
1"	2.562	2.062	.065	B2CM-G100	B2CM-R100
1½"	3.438	2.937	.065	B2CM-G150	B2CM-R150
2"	4.562	4.062	.065	B2CM-G200	B2CM-R200
2½"	5.688	5.187	.065	B2CM-G250	B2CM-R250
3"	6.812	6.312	.065	B2CM-G300	B2CM-R300
4"	8.937	8.312	.083	B2CM-G400	B2CM-R400

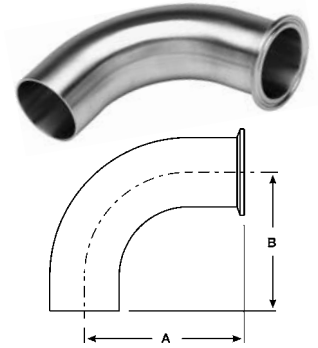

90° Plain Bevel Seat with Hex Nut x Buttweld Elbows, #7 finish - B2FP

Tube OD	Dimensions		Nominal Wall	304	
	A	B		Part Number	
1"	2.780	2.062	.065	B2FP-G100	
1½"	3.656	2.937	.065	B2FP-G150	
2"	4.812	4.062	.065	B2FP-G200	
2½"	6.062	5.187	.065	B2FP-G250	
3"	7.218	6.312	.065	B2FP-G300	
4"	9.343	8.312	.083	B2FP-G400	

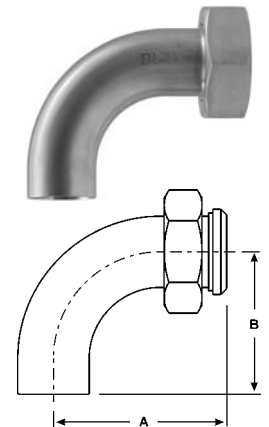

* Hex nut is CF8 (304) stainless

H

Buttweld Elbows

45° Buttweld Elbows with Tangents, #7 finish - B2KS

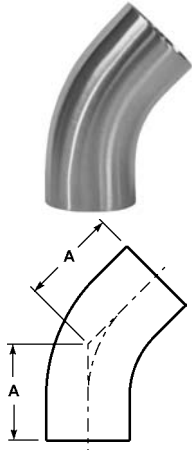

Tube OD	Dimension A	Nominal Wall	304	316L
			Part Number	Part Number
1/2"	2.250	.065	---	B2KS-R50P
3/4"	2.250	.065	---	B2KS-R75P
1"	1.188	.065	B2KS-G100P	B2KS-R100P
1 1/2"	1.625	.065	B2KS-G150P	B2KS-R150P
2"	2.312	.065	B2KS-G200P	B2KS-R200P
2 1/2"	3.000	.065	B2KS-G250P	B2KS-R250P
3"	3.688	.065	B2KS-G300P	B2KS-R300P
4"	4.812	.083	B2KS-G400P	B2KS-R400P

Note: #3, #5 and electropolish finishes are available.

H

45° Buttweld Elbows, #7 finish - B2WK

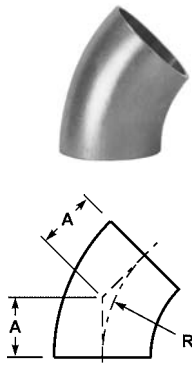

Tube OD	Dimensions		Nominal Wall	304	316L
	A	R		Part Number	Part Number
1/2"	.466	1.125	.065	---	B2WK-R50P
3/4"	.466	1.125	.065	---	B2WK-R75P
1"	.625	1.500	.065	B2WK-G100P	B2WK-R100P
1 1/2"	.937	2.250	.065	B2WK-G150P	B2WK-R150P
2"	1.250	3.000	.065	B2WK-G200P	B2WK-R200P
2 1/2"	1.562	3.750	.065	B2WK-G250P	B2WK-R250P
3"	1.875	4.500	.065	B2WK-G300P	B2WK-R300P
4"	2.500	6.000	.083	B2WK-G400P	B2WK-R400P
6"	3.750	9.000	.109	B2WK-G600P	B2WK-R600P
8"	5.000	12.000	.120	B2WK-G800P	B2WK-R800P
10"	6.250	15.000	.109	B2WK-G1000P	B2WK-R1000P
12"	7.500	18.000	.120	B2WK-G1200P	B2WK-R1200P

Note: #3, #5 and electropolish finishes are available.

45° Clamp x Buttweld Elbows, #7 finish - B2KM

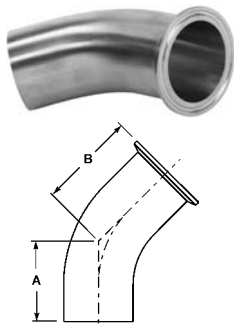

Tube OD	Dimensions		Nominal Wall	304	316L
	A	B		Part Number	Part Number
1"	1.188	1.688	.065	B2KM-G100	B2KM-R100
1 1/2"	1.625	2.125	.065	B2KM-G150	B2KM-R150
2"	2.312	2.812	.065	B2KM-G200	B2KM-R200
2 1/2"	3.000	3.500	.065	B2KM-G250	B2KM-R250
3"	3.688	4.188	.065	B2KM-G300	B2KM-R300
4"	4.812	5.437	.083	B2KM-G400	B2KM-R400

Other types of 45° Buttweld Elbows are available
call Dixon Sanitary for information



B2KT



B2KP

Buttweld Sweep Elbows

90° Buttweld Sweep Elbows, 12" - B2SXL



Tube OD	Dimensions		316L Part Number
	A	R	
1½"	12	12	B2SXL12-R150
2"	12	12	B2SXL12-R200
3"	12	12	B2SXL12-R300
4"	12	12	B2SXL12-R400

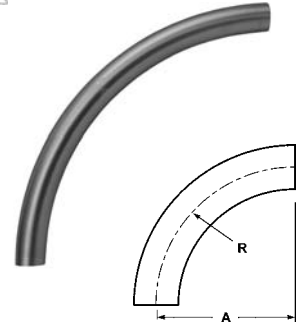

90° Buttweld Sweep Elbows, 18" - B2SXL



Tube OD	Dimensions		316L Part Number
	A	R	
1½"	18	18	B2SXL18-R150 NEW
2"	18	18	B2SXL18-R200
2½"	18	18	B2SXL18-R250
3"	18	18	B2SXL18-R300

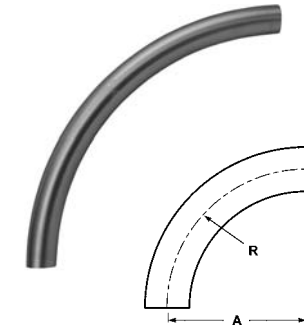

H

90° Buttweld Sweep Elbows, 24" - B2SXL



Tube OD	Dimensions		316L Part Number
	A	R	
1½"	24	24	B2SXL24-R150 NEW
2"	24	24	B2SXL24-R200
2½"	24	24	B2SXL24-R250
3"	24	24	B2SXL24-R300

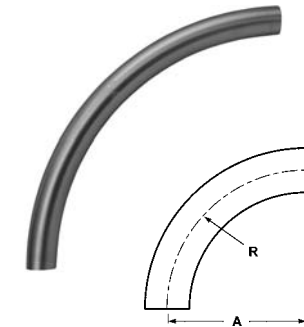

90° Buttweld Sweep Elbows, 36" - B2SXL



Tube O.D.	Dimensions		316L Part Number
	A	R	
3"	36	36	B2SXL36-R300
4"	36	36	B2SXL36-R400

